

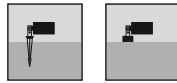

**Marcopia 2**  
ESU624

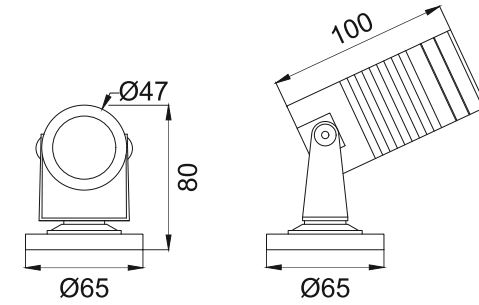

Spike Mounted Base Mounted

Housing Finish	<input type="checkbox"/> HG Grey <input type="checkbox"/> HB Black <input type="checkbox"/> HC Custom
Voltage	<input type="checkbox"/> 24V DC24V <input type="checkbox"/> 230V AC230V
IP Rating	<input type="checkbox"/> 65 IP65

Unit : MM

**Surface Uplighter**

**Illumination Options**

<input type="checkbox"/> 27W 27W <input type="checkbox"/> 27S 27W		6W
<input type="checkbox"/> 30W 30W <input type="checkbox"/> 30S 30M		6W

	510lm
	535lm

	2700K
	3000K

	10° 15° 24° 38°
	10° 15° 24° 38°

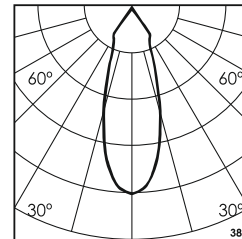
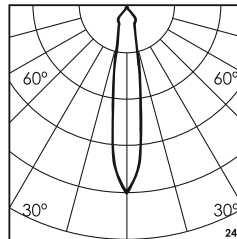
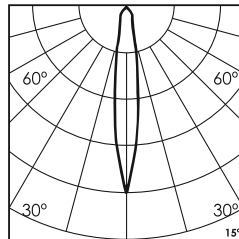
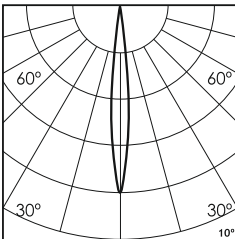
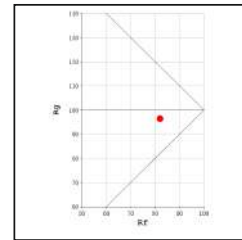
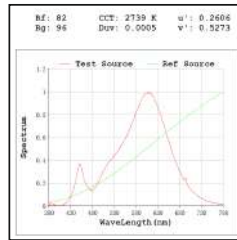
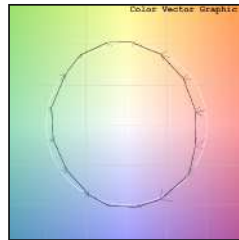
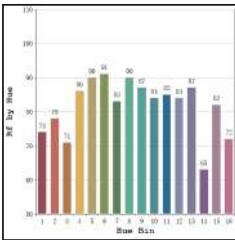

\* All degree & wattage options with photometric data available on request \*  
 \* IP variants & list of accessories for this model available on request \*

**Technical Details**

Housing	Aluminum body	LOR	~80%
Mounting	Base / Spike mounted	Operating voltage	24V/230V
Light Source	High Power LED	CRI (Ra)	>80
Weight	490gms	MacAdam Ellipse	<3
Junction Temperature	Tj<75°C	Luminous Efficacy	~75lm/W
Heat Sink	Al6063	Life Time	L80-B10 50,000hrs.

**Accessories**

**Power Options**

- N Non Dimmable
- P Phase Cut Dimming
- A 0-10/ 1-10V Analog
- D DALI Dimming

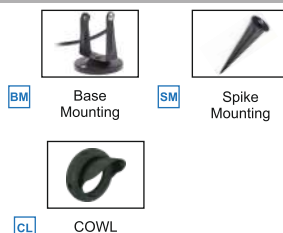
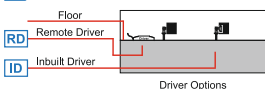

**Other Products in this Series**



Ordering code : ESUxxx(model no)-Hx(housing)-xxx(voltage)-xx(IP)-xxxx(watt+cct+beam angle)-x(dimming)-xx(mounting)-xx(cowl)  
 Example : {624} {HG} {24V} {65} {627S} {A} {BM} {CL}