

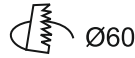

**Mars Tilt
 IRD704**

**Mars Tilt Mini
 IRD704A**



**Mars Tilt Max
 IRD704B/C**

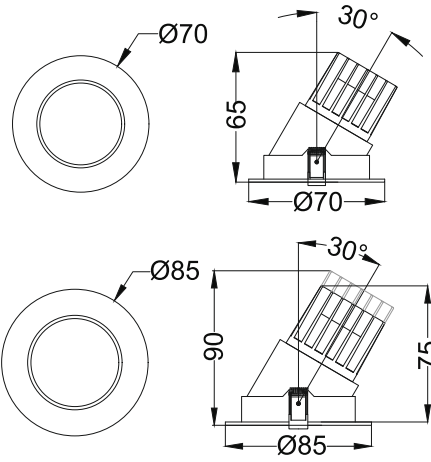

Finish Options

- Trim**
- TW White
 - TB Black
 - TC Custom

- Baffle**
- BW White
 - BB Black
 - BC Custom

- IP Rating**
- 20 IP20
 - 44 IP44

Unit : MM

Recessed Adjustable Downlight

Illumination Options



7W & 10W/15W



550lm & 780lm/1180lm



2700K



15° 24°
 38°



7W & 10W/15W



605lm & 865lm/1295lm



3000K



15° 24°
 38°

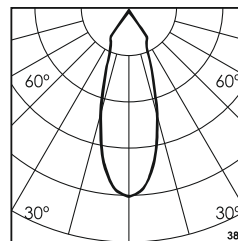
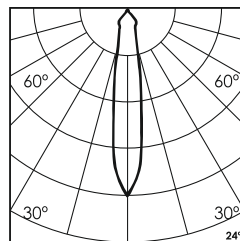
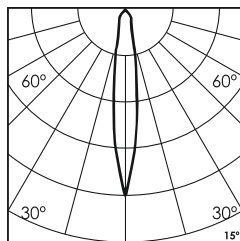
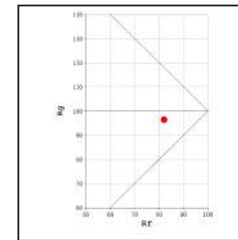
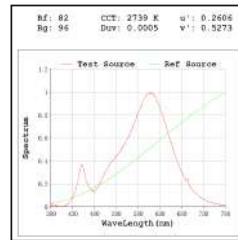
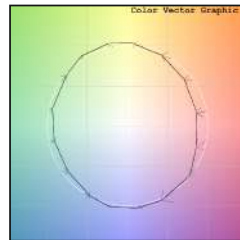
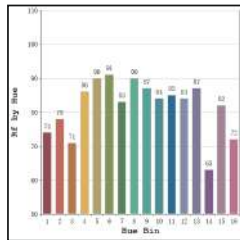

Technical Details

Housing	Aluminum die casting	LOR	~80%
Mounting	Spring - Ceiling mounted	UGR	<19
Light Source	Single source LED	CRI (Ra)	>80
Weight	150/240/280gms	MacAdam Ellipse	<3
Junction Temperature	Tj<75°C	Luminous Efficacy	~75lm/W
Heat Sink	Al6063	Life Time	L80-B10 50,000hrs.

Accessories

Power Options

- N Non Dimmable
- P Phase Cut Dimming
- A 0-10/ 1-10V Analog
- D DALI Dimming

- H Honeycomb
- S Softening Lens
- D Diffused Lens
- C Clear Lens

Other Products in this Series

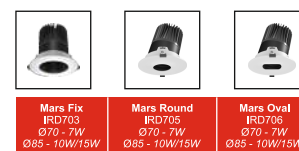

* All degree & wattage options with photometric data available on request *
 * IP variants & list of accessories for this model available on request *

Ordering code : IRDxxx(model no)-Tx(trim)-Bx(baffle)-xx(IP)-xxxx(watt+cct+beam angle)-x(dimming)-x(filter)
 Example : {704} {TW} {BW} {20} {727S} {A} {S}