



**Tenace LA
IRD596**

Trim



Trimless

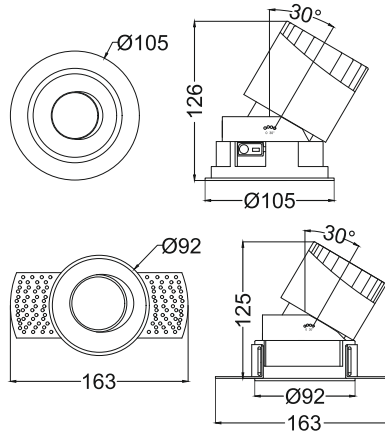

Finish Options

- Mounting**
- MT Trim
 - MT Trimless
- Reflector**
- RW White
 - RV Vivid Black
 - RM Matt
 - RS Specular
 - RP Satin Gold
 - RP Pearl Black
- IP Rating**
- 20 IP20
 - 44 IP44

Unit : MM

Recessed Adjustable Downlight

Illumination Options

- | | | | | |
|--|-----|---------------------------------|------------------------------------|--|
| <input type="checkbox"/> 27N 27S
<input type="checkbox"/> 27M | 20W | <input type="checkbox"/> 1800lm | <input type="checkbox"/> CCT 2700K | <input type="checkbox"/> 15° 24°
<input type="checkbox"/> 38° |
| <input type="checkbox"/> 30N 30S
<input type="checkbox"/> 30M | 20W | <input type="checkbox"/> 1860lm | <input type="checkbox"/> CCT 3000K | <input type="checkbox"/> 15° 24°
<input type="checkbox"/> 38° |

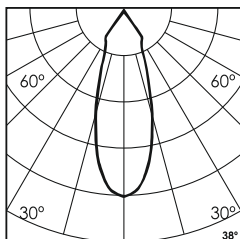
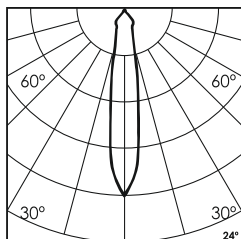
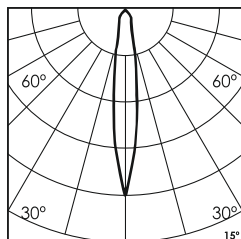
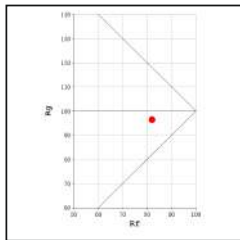
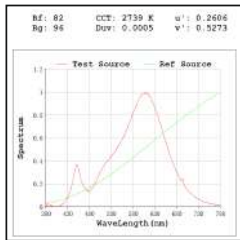
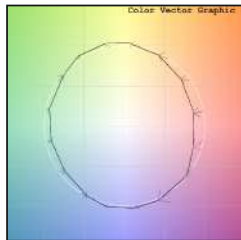
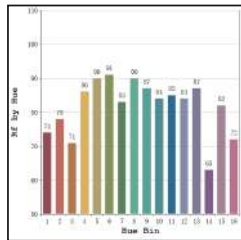

* All degree & wattage options with photometric data available on request *
* IP variants & list of accessories for this model available on request *

Technical Details

Housing	Aluminum die casting	LOR	~80%
Mounting	Spring / Trimless - Ceiling mounted	UGR	<19
Light Source	Single source LED	CRI (Ra)	>80
Weight	625gms	MacAdam Ellipse	<3
Junction Temperature	Tj<75°C	Luminous Efficacy	~75lm/W
Heat Sink	Al6063	Life Time	L80-B10 50,000hrs.

Accessories

- Power Options**
- N Non Dimmable
 - P Phase Cut Dimming
 - A 0-10/ 1-10V Analog
 - D DALI Dimming

- H Honeycomb
- S Softening Lens
- D Diffused Lens
- C Clear Lens

Other Products in this Series

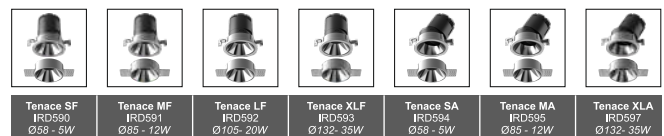

Ordering code : IRDxxx(model no)-Mx(mounting)-Rx(reflector)-xx(IP)-xxxxx(watt+cct+beam angle)-x(dimming)-x(filter)
Example : (596) (MT) (RW) (20) (2027S) (A) (S)