



**Tenace MA  
IRD595**

Trim



Trimless

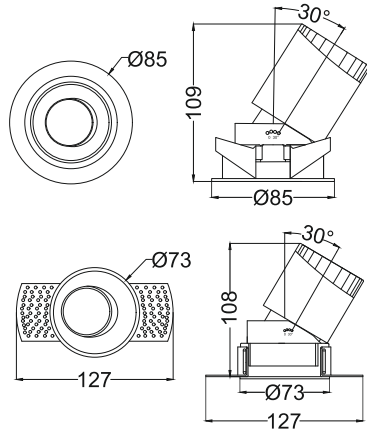
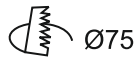

**Finish Options**

- Mounting**
- MT Trim
  - MT Trimless
- Reflector**
- RW White
  - RV Vivid Black
  - RM Matt
  - RS Specular
  - RP Satin Gold
  - RP Pearl Black
- IP Rating**
- 20 IP20
  - 44 IP44

Unit : MM

**Recessed Adjustable Downlight**

**Illumination Options**

- |                                  |  |     |  |        |  |       |  |         |
|----------------------------------|--|-----|--|--------|--|-------|--|---------|
| <input type="checkbox"/> 27N 27S |  | 12W |  | 1080lm |  | 2700K |  | 10° 24° |
| <input type="checkbox"/> 30N 30S |  | 12W |  | 1115lm |  | 3000K |  | 10° 24° |

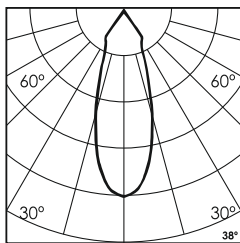
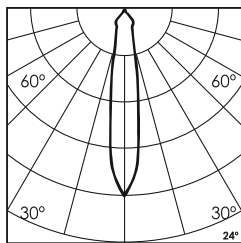
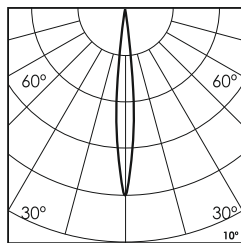
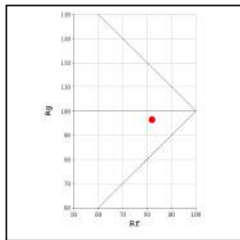
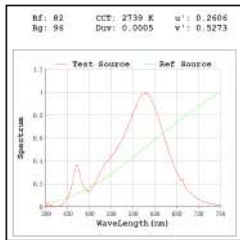
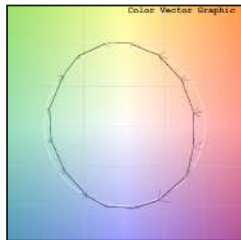
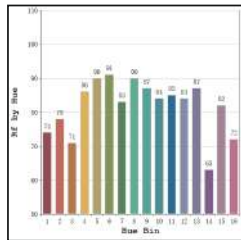

\* All degree & wattage options with photometric data available on request \*  
\* IP variants & list of accessories for this model available on request \*

**Technical Details**

Housing	Aluminum die casting	LOR	~80%
Mounting	Spring / Trimless - Ceiling mounted	UGR	<19
Light Source	Single source LED	CRI (Ra)	>80
Weight	310gms	MacAdam Ellipse	<3
Junction Temperature	Tj<75°C	Luminous Efficacy	~75lm/W
Heat Sink	Al6063	Life Time	L80-B10 50,000hrs.

**Accessories**

- Power Options**
- N Non Dimmable
  - P Phase Cut Dimming
  - A 0-10/ 1-10V Analog
  - D DALI Dimming

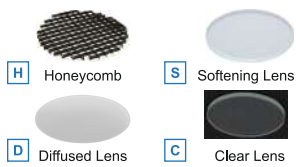

**Other Products in this Series**

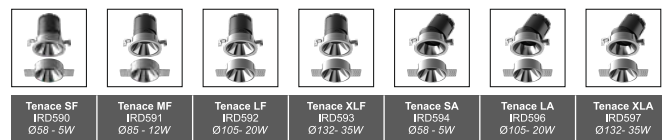

Ordering code : IRDxxx(model no)-Mx(mounting)-Rx(reflector)-xx(IP)-xxxxx(watt+cct+beam angle)-x(dimming)-x(filter)  
Example : {595} {MT} {RW} {20} {1227S} {A} {S}