

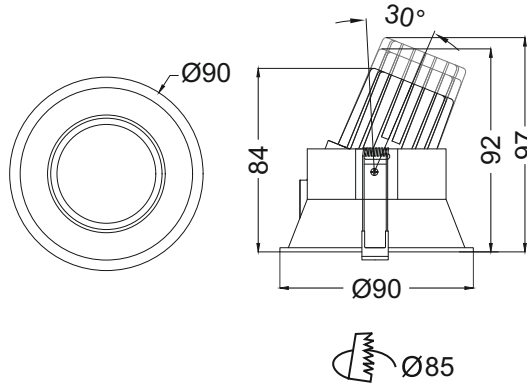

Valora Round
IRD763



Finish Options

- Housing HW White
 HB Black
 HC Custom
- IP Rating 20 IP20

Unit : MM

Recessed Adjustable Downlight

Illumination Options



5W/7W/10W



410lm/570lm/810lm



2700K



15° 24°
 38°



5W/7W/10W



435lm/605lm/860lm



3000K



15° 24°
 38°

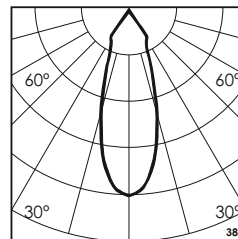
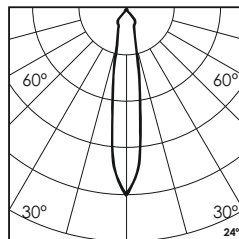
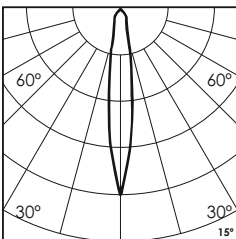
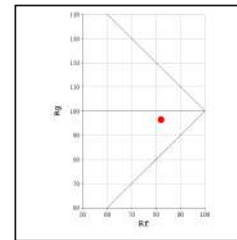
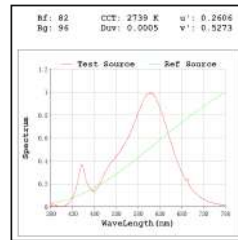
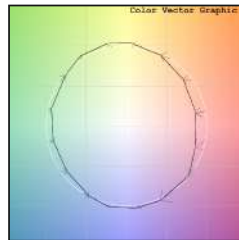
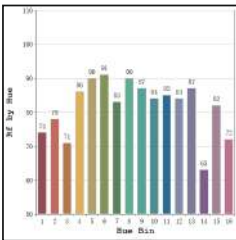

* All degree & wattage options with photometric data available on request *
 * IP variants & list of accessories for this model available on request *

Technical Details

Housing	Aluminum die casting	LOR	~80%
Mounting	Spring - Ceiling mounted	UGR	<19
Light Source	Single source COB LED	CRI (Ra)	>80
Weight	125/150/160gms	MacAdam Ellipse	<3
Junction Temperature	Tj<75°C	Luminous Efficacy	~75lm/W
Heat Sink	Al6063	Life Time	L80-B10 50,000hrs.

Accessories

Power Options

- N Non Dimmable
 P Phase Cut Dimming
 A 0-10/ 1-10V Analog
 D DALI Dimming

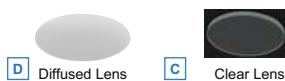

Other Products in this Series



Ordering code : IRDxxx(model no)-Hx(housing)-xx(IP)-xxxx(watt+cct+beam angle)-x(dimming)-x(filter)
 Example : {763} {HW} {20} {1027M} {A} {D}