

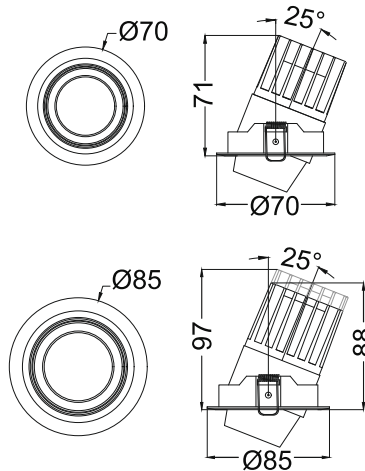

Zizzi Focus Mini
IRD414A



Zizzi Focus Max
IRD414B/C



Finish Options

- Trim TW White
 TB Black
 TC Custom

- Baffle BW White
 BB Black
 BC Custom

- IP Rating 20 IP20
 44 IP44

Unit : MM

Zizzi Focus
IRD414

Recessed Adjustable Downlight

Illumination Options



7W & 10W/15W



630lm & 900lm/1350lm



2700K



15°
24°



7W & 10W/15W



630lm & 900lm/1350lm



3000K



15°
24°

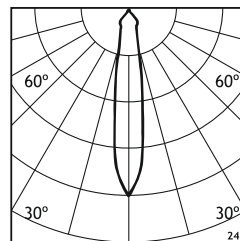
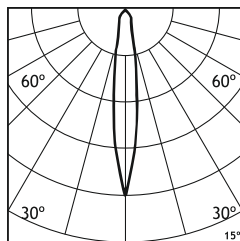
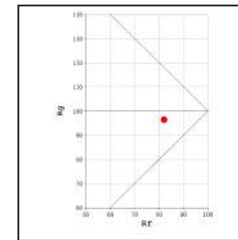
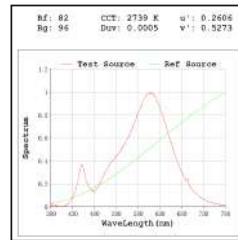
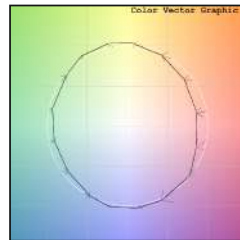
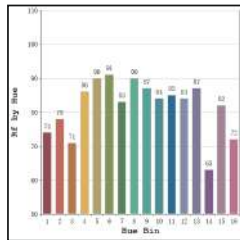

Technical Details

Housing	Aluminum die casting	LOR	~80%
Mounting	Spring - Ceiling mounted	UGR	<19
Light Source	Single source LED	CRI (Ra)	>80
Weight	195/255/295gms	MacAdam Ellipse	<3
Junction Temperature	Tj<75°C	Luminous Efficacy	~75lm/W
Heat Sink	Al6063	Life Time	L80-B10 50,000hrs.

Accessories

Power Options

- N Non Dimmable
 P Phase Cut Dimming
 A 0-10/ 1-10V Analog
 D DALI Dimming

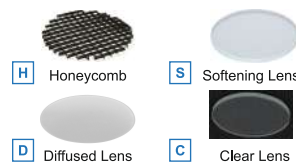

Other Products in this Series



Ordering code : IRDxxx(model no)-Tx(trim)-Bx(baffle)-xx(IP)-xxxx(watt+cct+beam angle)-x(dimming)-x(filter)
Example : (414) (TW) (BW) (20) (727S) (A) (S)

* All degree & wattage options with photometric data available on request *
* IP variants & list of accessories for this model available on request *