

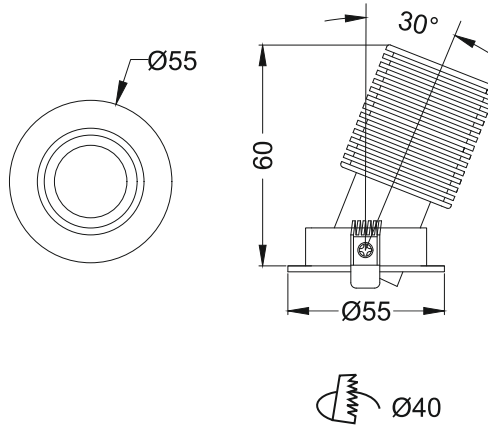

**iSkew Tilt  
IRD771**



**Finish Options**

Trim  TW White  
 TB Black  
 TC Custom

Baffle  BW White  
 BB Black  
 BC Custom

IP Rating  20 IP20

Unit : MM

**Recessed Adjustable Downlight**

**Illumination Options**



7W



525lm



2700K



15° 24°  
38°



7W



545lm



3000K



15° 24°  
38°

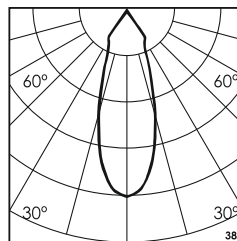
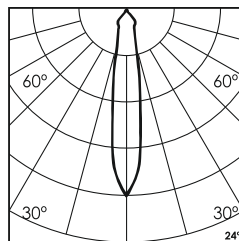
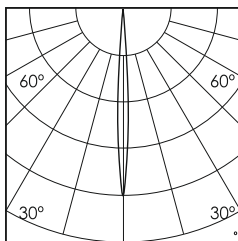
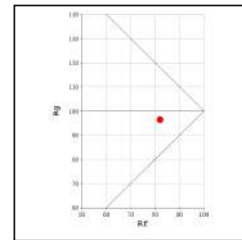
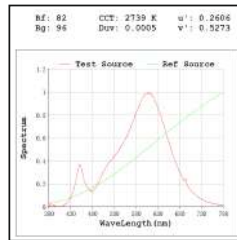
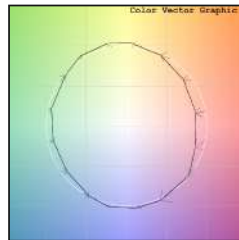
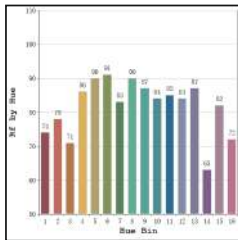

\* All degree & wattage options with photometric data available on request \*  
 \* IP variants & list of accessories for this model available on request \*

**Technical Details**

Housing Aluminum die casting  
 Mounting Spring - Ceiling mounted  
 Light Source Single source LED  
 Weight 98gms  
 Junction Temperature Tj<75°C  
 Heat Sink Al6063

LOR ~80%  
 UGR <19  
 CRI (Ra) >80  
 MacAdam Ellipse <3  
 Luminous Efficacy ~75lm/W  
 Life Time L80-B10 50,000hrs.

**Accessories**

**Power Options**

N Non Dimmable  
 P Phase Cut Dimming  
 A 0-10/ 1-10V Analog  
 D DALI Dimming

**Other Products in this Series**



**iSkew Fix  
IRD768  
Ø55 - 7W**

Ordering code : IRDxxx(model no)-Tx(trim)-Bx(baffle)-xx(IP)-xxxx(watt+cct+beam angle)-x(dimming)  
 Example : {771} {TW} {BW} {20} {727S} {A}